

ONDERDEEL TEKENING

BSM75

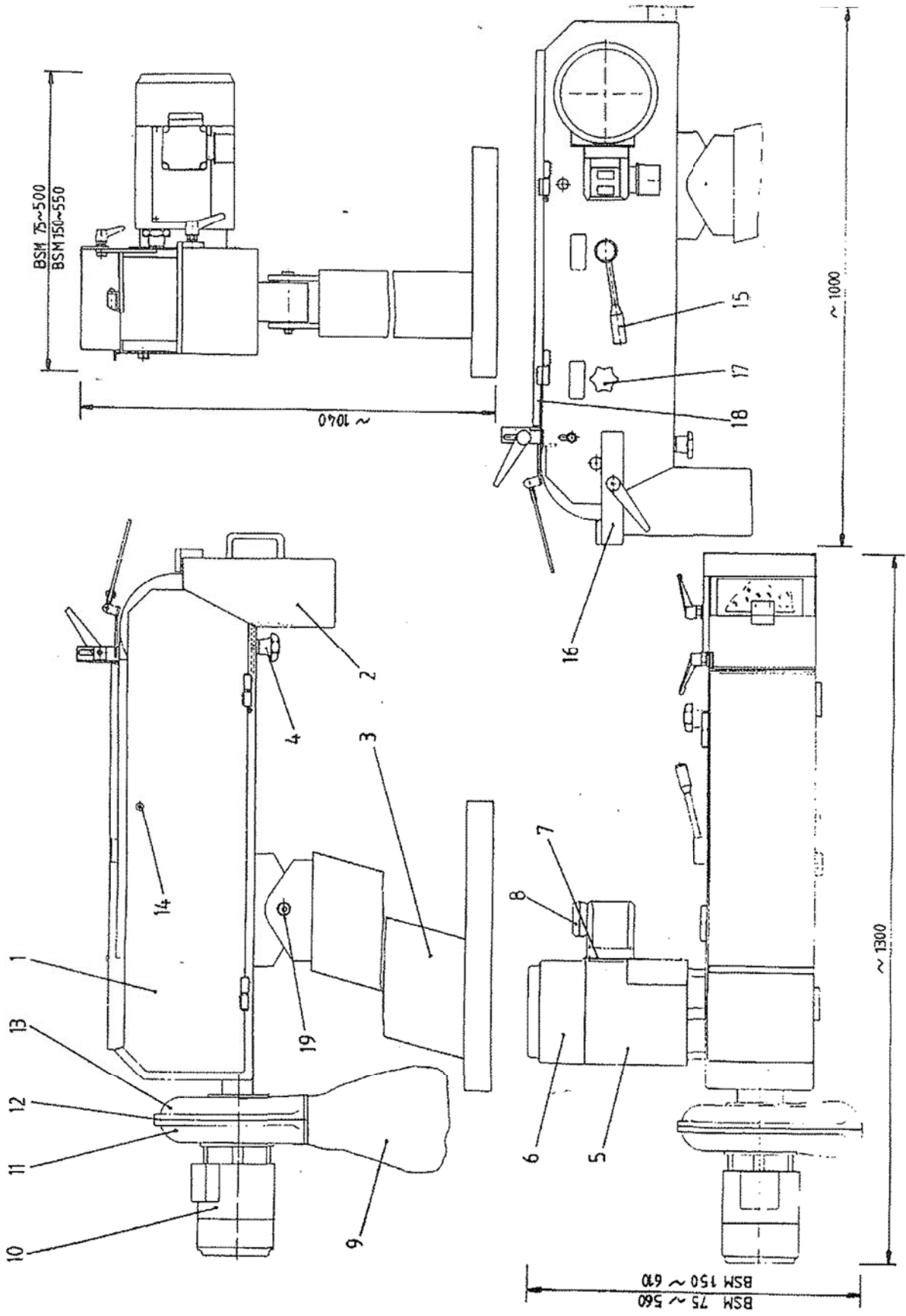

BSM75

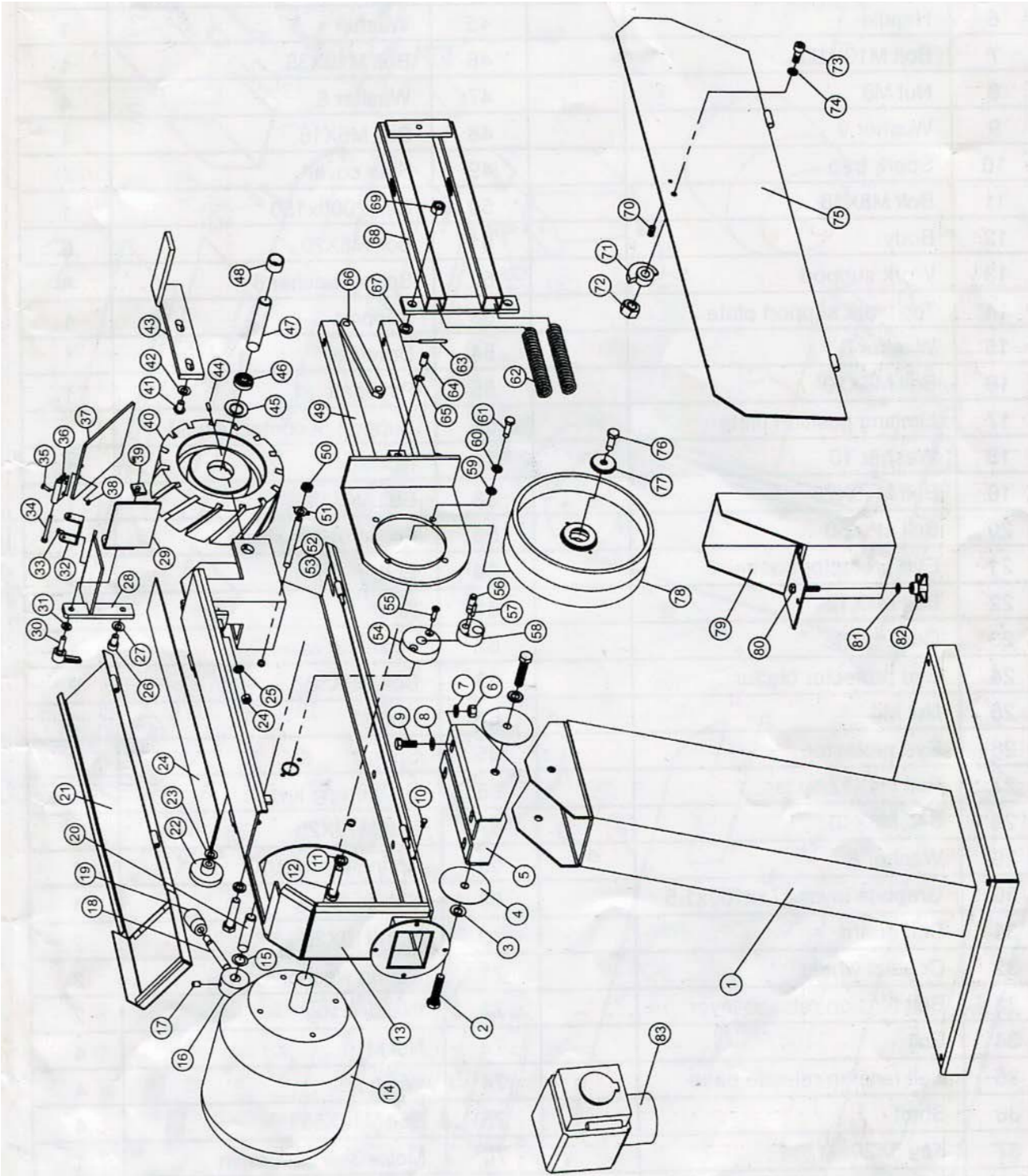

BSM75

Part #	Description	Q'ty	Part #	Description	Q'ty
1	Stand	1	42	Washer	2
2	Hex. Screw M12x30	2	43	Work Support	1
3	Washer	2	44	Screw M5x16	1
4	Paper Spacer	2	45	Stop Ring	2
5	Clamp for angle & height adjustment	2	46	Bearing	2
			47	Shaft	1
6	Nut M10	4	48	Spacer	2
7	Washer	4	49	Motor Support	1
8	Washer	4	50	Nut	1
9	Hex. Screw M10x20	4	51	Butterfly Spring	1
10	Hex. Screw M5x10	2	52	Screw Bar	1
11	Washer	2	53	Washer	2
12	Hex. Screw M12x50	2	54	Base	1
13	Body	1	55	Screw M6x25	2
14	Motor	1	56	Shaft	1
15	Washer	1	57	Elasticity Pin	1
16	Belt Tension Release Base		58	Eccentric Wheel	1
17	Inner Hex. Screw M8x20	1	59	Washer	4
18	Belt Tension Release Lever	1	60	Bolt M8x22	4
19	Sleeve	1	61	Spring	2
20	Shaft	1	62	Spring	2
21	Belt Guard	1	63	Elasticity Pin	2
22	Tracking Adjust Knob	1	64	Pin Shaft	1
23	Washer	1	65	Stop Ring	3
24	Graphite Layer	1	66	Draw Bar	1
25	Nut	2	67	Butterfly Spring	12
26	Hex. Screw M10x15	3	68	Support	1
27	Washer	2	69	Belt Adjustment Device	
28	Top Work Support	1	70	Screw	1
29	Top Work Support Plate	1	71	Protect Buckle	1
30	Lock Handle	1	72	Nut	2
31	Washer	1	73	Screw M10x25	1
32	Eye Protector Base	1	74	Washer	1
33	Screw M5x8	2	75	Side Cover	1
34	Hex. Screw M5x50	1	76	Bolt M10x30	1
35	Screw M4x12	2	77	Washer	1
36	Eye Protector Binder	1	78	Steering Wheel	1
37	Description	1	79	Spark Trap	1
38	Eye Protector	2	80	Bolt M8x15	1
39	Nut M4	1	81	Washer	1
40	Block With Thread	1	82	Knob	1
41	Contact Wheel Hex. Screw M10x15	2	83	Overload Protection Switch (Only available for CE)	1