

ONDERDEELTEKENING

DT40VA

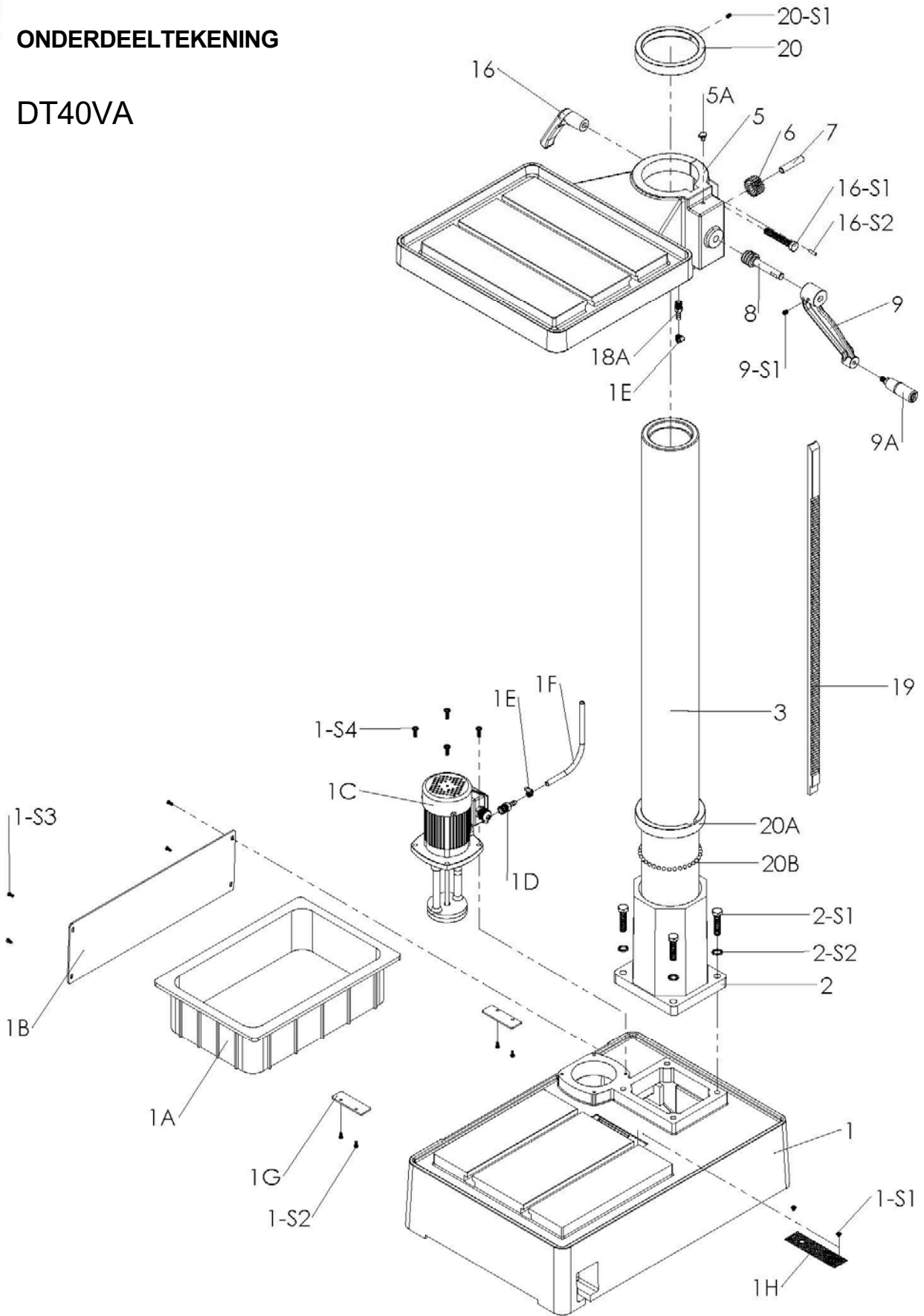

DT40VA

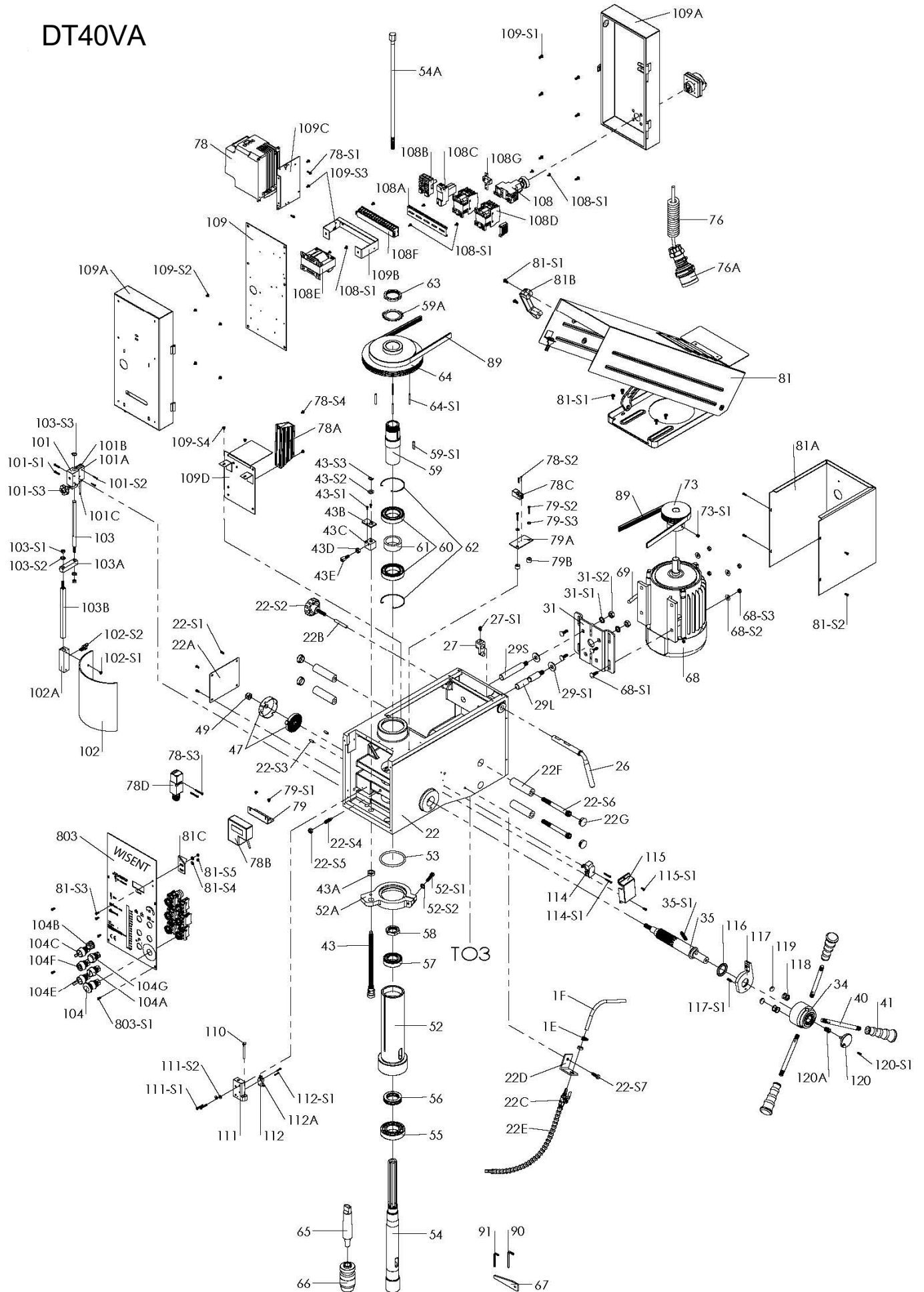

DT40VA

1	BASE
1A	WATER TANK
1B	BASE COVER
1C	PUMP MOTOR 400V
1D	ADAPTER
1E	CLAMP
1F	HOSE
1G	WATER TANK COVER
1H	HOSE COVER
1-S1	SCREW
1-S2	SCREW
1-S3	SCREW
1-S4	SCREW
2	COLUMN HOLDER
2-S1	BOLT
2-S2	SPRING WASHER
3	COLUMN
5	TABLE BRACKET
5A	OIL CUP
6	GEAR
7	GEAR BRACKET
8	WORM
9	TABLE HANDLE
9A	HANDLE BOLT
9-S1	SET SCREW
14	SCALE
15	ANGLE SCALE
16	CLAMP HANDLE
16-S1	CLAMP BOLT
16-S2	PIN
18	TABLE
18A	ADAPTER
18B	BUSH
18C	BUSH
18-S1	BOLT
18-S2	SPRING WASHER
18-S3	WASHER
18-S4	SET SCREW
18-S5	NUT
18-S6	LEAD BOLT
18-S7	PIN
18-S8	SWIVEL HANDLE
19	RACK
20	RACK RING
20A	RACK RING
20B	STEEL BALLS
20-S1	SET SCREW
22	HEAD BODY
22A	SIDE COVER
22B	SHAFT
22C	VALVE
22D	FIXING PLATE
22E	NOZZLE
22F	ALUMINUM FIXED (FOR DT40V)
22G	HOLE PLUGS (FOR DT40V)
22-S1	SCREW
22-S2	LEAD BOLT
22-S3	PIN
22-S4	SET SCREW
22-S5	NUT
22-S6	SET SCREW
22-S7	BOLT

26	SHIFTER BAR
27	SHIFTER
27-S1	SET SCREW
29L	SLIDE BAR(L)
29S	SLIDE BAR(S)
29-S1	WASHER
31	MOTOR BASE PLATE
31-S1	SPRING WASHER
31-S2	NUT
34	HANDLE BODY
35	FEED SHAFT
35-S1	SET SCREW
40	FEED HANDLE
41	GRIP
43	DEPTH ROD
43A	HEX NUT
43B	LIMIT PLATE
43C	POSITION SET BRACKET
43D	HEX NUT
43E	DEPTH SCALE
43-S1	SCREW
43-S2	WASHER
43-S3	C TYPE BUCKLE
47	SPRING CAP
49	NUT
52	QUILL
52A	SLEEVE
52-S1	BOLT
52-S2	SPRING WASHER
53	RUBBER WASHER
54	SPINDLE
54A	DRAW BAR
55	BALL BEARING
56	THRUST BEARING
57	BALL BEARING
58	SPINDLE NUT
59	SPINDLE SLEEVE
59A	LOCK WASHER
59-S1	KEY (FOR DT40V)
60	BALL BEARING
61	COLLAR
62	SNAP RING
63	PULLEY NUT
64	SPINDLE PULLEY
64-S1	PIN
65	TAPER ARBOR
66	DRILL CHUCK
67	DRILL SHIFTER
68	MOTOR
68A	FANS
68B	MOTOR FANS COVER
68-S1	BOLT
68-S2	WASHER
68-S3	NUT
69	MOTOR WIRE
73	MOTOR PULLEY
73-S1	SET SCREW
76	WIRE
76A	WIRE PLUG
78	SPEED CONTROLLER
78	JKM CAM SWITCH (FOR DT3218)
78A	BRAKING RESISTOR

78B	RPM DISPLAY UNIT
78C	SPEED SENSOR
78D	MICOR SWITCH
78-S1	SCREW
78-S2	SCREW
78-S3	SCREW
78-S4	SCREW
79	RPM SWITCH RETAINER PLATE
79A	PROXIMITY SWITCH RETAINER PLATE
79B	BUSH
79-S1	SCREW
79-S2	SCREW
79-S3	WASHER
81	PULLEY COVER
81A	REAR PULLEY COVER
81B	GRAB HANDLES
81C	PLATE
81-S1	SCREW
81-S2	SCREW
81-S3	SCREW
81-S4	WASHER
81-S5	NUT
86	TRANSMITTING PULLEY (FOR DT3218)
86-S1	SNAP RING
87	BALL BEARING(FOR DT3218)
88	PULLEY SHAFT PLATE(FOR DT3218)
88A	PULLEY SHAFT (FOR DT3218)
88-S1	SCREW (FOR DT3218)
88-S2	SPRING WASHER (FOR DT3218)
88-S3	WASHER
89	V-BELT
90	ALLEN WRENCH (L)
91	ALLEN WRENCH (S)
101	MICRO SWITCH BRACKET
101A	MICRO SWITCH
101B	MICRO SWITCH BOARD COVER
101C	MICRO SWITCH WIRE
101-S1	SCREW
101-S2	SCREW
101-S3	LEAD BOLT
102	SAFETY GUARD
102A	SAFETY GUARD SLIDE
102-S1	SCREW
102-S2	LEAD BOLT
103	BRACKET ROD
103A	SUPPORT ARM
103B	LOWER BRACKET ROD
103-S1	HEX NUT
103-S2	SPRING WASHER
103-S3	C-RING
104	EMERGENCY STOP SWITCH
104-A	ON SWITCH
104-B	RPM SWITCH
104-C	CHANGE SWITCH
104-E	CHANGE SWITCH
104-F	OFF SWITCH
104-G	FAULT LAMP
108	GENERAL SWITCH
108A	ALUMINUM STRIP
108B	FUSE STE
108C	CONTACTOR RELAY
108D	ELECTRIC CONTROLLER
108E	TRANSFORMER
108F	SOCKET

108G	GROUNDING
108H	PUMP CONTACTOR (FOR DT3218)
108J	OVERLOAD RELAY (FOR DT3218)
108-S1	SCREW
109	WIRE TERMINAL PLATE
109A	GENERAL SWITCH BOX
109B	SWITCH BRACKET
109C	SWITCH BRACKET
109D	SWITCH BRACKET(FOR DT40V)
109-S1	SCREW
109-S2	SCREW
109-S3	SCREW
109-S4	SCREW
110	STEEL BAR
111	MICRO SWITCH PLATE
111-S1	SCREW
111-S2	WASHER
112	MICRO SWITCH BODY
112A	MICRO SWITCH TRIGGER
112-S1	SCREW
114	MICRO SWITCH
114-S1	SCREW
115	MICRO SWITCH COVER
115-S1	SCREW
116	THRUST BEARING
117	TAPPING SENSOR
117-S1	PIN
118	SPRING
119	MAGNET
120	ORIENTATION BOLT
120A	SPRING
120-S1	SCREW
V105	WISE BODY
V105A	SET SLIDER
V106	LEADSCREW
V106A	SET SLIDER
V107	MOVING STAND
V107-S1	SET SCREW
V107-S2	SET SCREW
V107-S3	NUT
V109	WISE HANDLE
V109-S1	SET SCREW
V110	MOUNT PIECE
V110-S1	SCREW
803	SWITCH COVER
803-S1	SCREW